

B.L. WALLACE-DISTRIBUTOR, INC.

8542 La Salle St., Cypress, CA 90630 Phone (714)761-2071 FAX (714)761-0460
www.blwallace.com

- Etched polypropylene face
- Face anchored in concrete
- Ultra-violet inhibitor
- Exceeds ASTM-D1693 Standards for Environmental Stress Cracking Resistance

REINFORCED CONCRETE LID

No. B09XD

20 lbs.

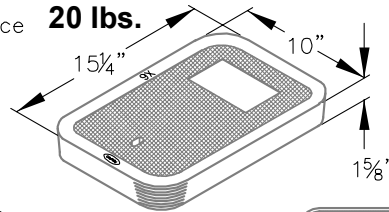

UTILITY BOX

No. B09XBOX

90 lbs.

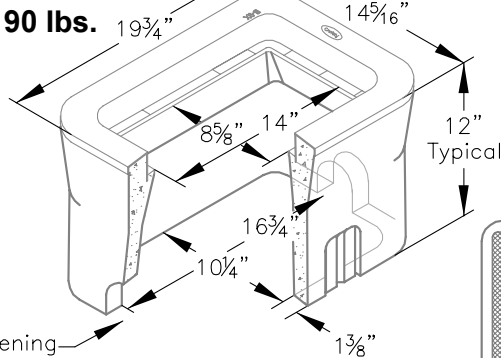

Mouse Hole Opening
(1 Each End) Typical

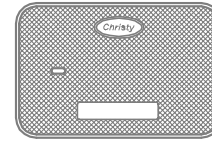

B09XC

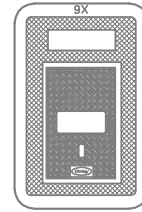

B09XG

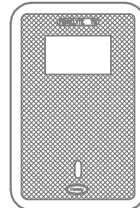

FL09X

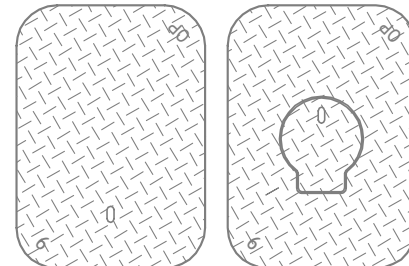

B09-61D

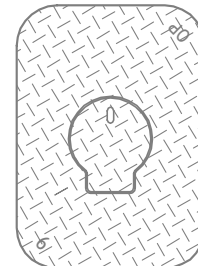

B09-61G

A high density reinforced concrete box with non-settling shoulders positioned to maintain grade and facilitate back filling. Approximate dimensions and weight shown.

Ordering Code	Item	Approx. Shipping Weight	Description
B09XBOX	BOX	90	B09X Utility Box (10 1/4" x 16 3/4") interchangeable with Brooks #36- 28 per pallet
B09XC	LID	22	Cast iron
B09XD	LID	20	Reinforced concrete
B09XG	LID	18	Reinforced concrete with 5" x 8" cast iron, self-closing, reading lid with frame
B09XTL	LID	23	Cast iron lid with lock
B09K	KEY	1	Key for cast iron lid with lock
FL09X	LID	5	Fibrelyte lid, non-concrete
B09-61D	COVER	22	Steel checker plate
B09-61G	COVER	22	Steel checker plate with 6" round, self-closing reading lid
B09X12	EXTENSION	87	12" Reinforced concrete- 28 per pallet
B09SL	SLAB	32	Reinforced concrete (13 1/4" x 19 3/4")

Galvanizing available on all steel covers.



Oldcastle Precast[®]
Enclosure Solutions
MADERA/TRACY/ROSEVILLE/PHOENIX

Copyright © 2008 Oldcastle Precast Inc.

B09X BOX

FILE NAME: 036UWMB9XBOX_ISO

ISSUE DATE: January, 2008

B09X UTILITY BOX

10-1/4" x 16-3/4"

