

B1324

CHRISTY®

COVER

Style:	Flush
Material:	Steel Checker Plate
Model:	16" x 27"
Weight:	70 lbs
Options:	Special Markings
Surface:	Skid Resistant & Marked*
Coefficient of Friction:	>0.6 ASTM 1028
Performance:	H20, AASHTO M309

Cover comes standard with permanent markings for manufacturer, load rating, model size and manufacturing location.

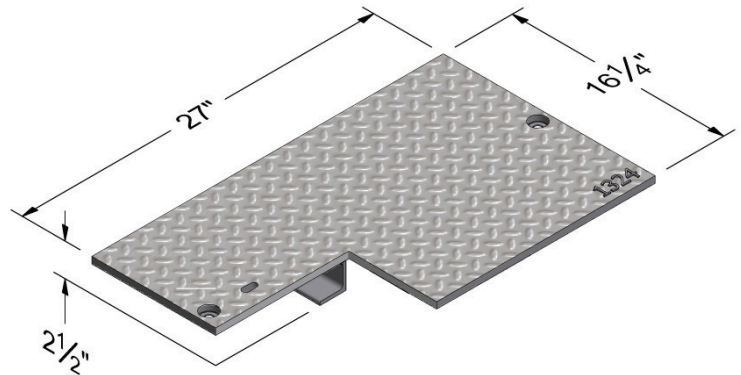

BODY

Material:	Reinforced Concrete with Steel Frame
Model:	19" x 30"
Weight:	166 lbs
Wall Type:	Straight
Mouseholes:	0
Performance:	H20, AASHTO M309

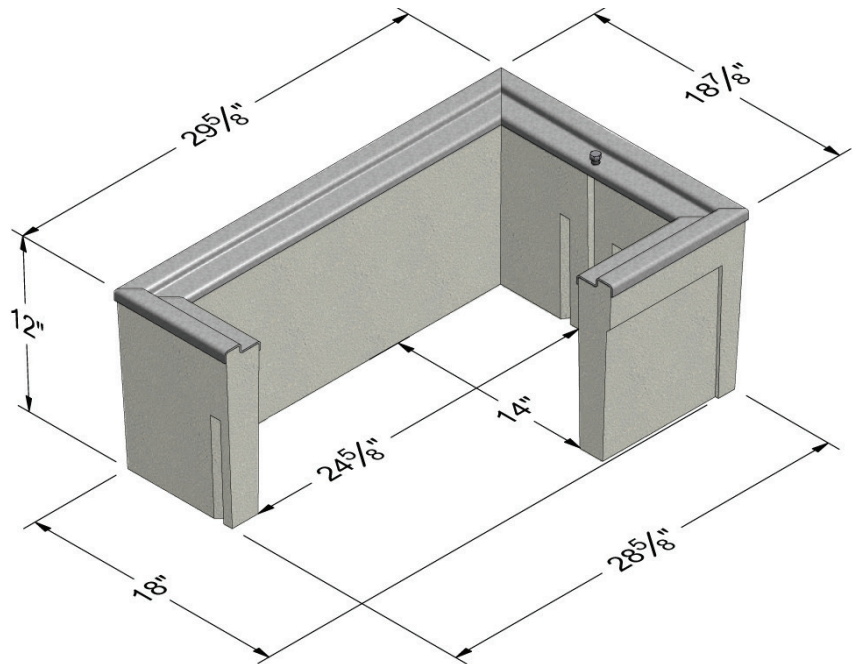

COVER OPTIONS

Reader Door
Bolt Down Locking
Galvanizing

LOAD RATING / NOTES



TRAFFIC RATED
AASHTO H20

Actual load rating is determined by the box and cover combination.

WARNING: Cancer and Reproductive Harm - www.P65Warnings.ca.gov

All information contained on this sheet is current at the time of publication.
Oldcastle reserves the right to discontinue or update product information without notice.

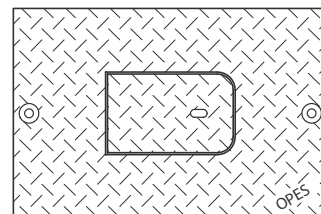

Reader Door Detail

Revision 12/06/18
© 2018 Oldcastle Infrastructure